

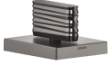



20 005 706

- with WAVES structure
- hole diameter 32 mm
- rosette 60 x 47 mm
- with hot marking



	Brushed Dark Platinum	20 005 706-99
	Chrome	20 005 706-00
	Brushed Platinum	20 005 706-06
	Dark Chrome	20 005 706-19
	Brushed Champagne (22kt Gold)	20 005 706-46
	Champagne (22kt Gold)	20 005 706-47

20 005 706

mm [inches]

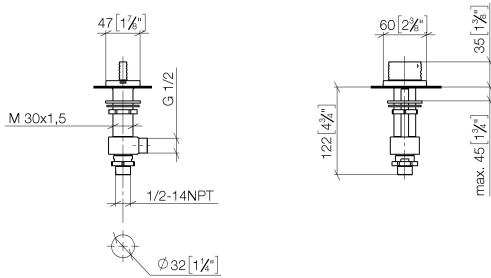

Flow rate chart



Codes & Standards

ADA

ASME
A112.18.1/CSA
B125.1

NSF/ANSI 372

NSF/ANSI/CAN
61



CL.1 Deck valve anti-clockwise closing hot - Brushed Dark Platinum

CL.1

20 005 706

Certificates

WRAS_1804020. IAPMO_N-4976. LGA_28687. IAPMO_4976 (4). IAPMO_6397.

WRAS_240202020.

20 005 706

Parts for other finishes can be found here: [Chrome](#)

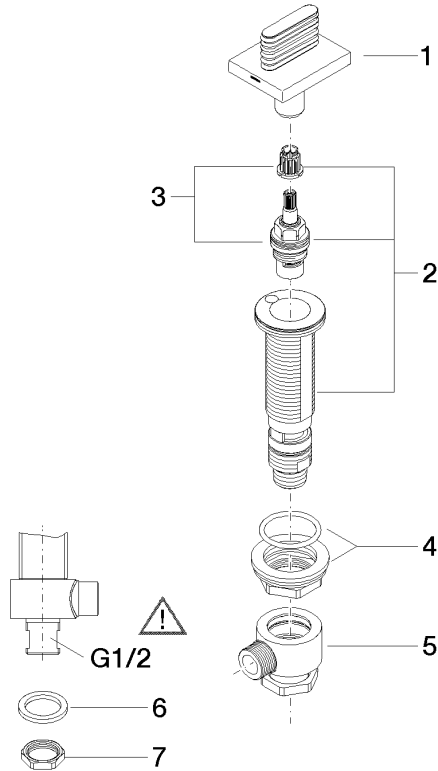

Spare parts list

No.	Item Number	Name	Quantity used	Delivery time
1	90 20 70 055 07-99	handle (hot)	1	30
2	04 17 11 058 52 90	side panel	1	2
3	90 90 03 152 00 90	top	1	2
4	04 23 10 032 78 90	fixing set	1	2
5	04 17 11 023 10 90	distributor	1	2
6	90 23 30 040 00-99	threaded connector	1	30
7	09 30 11 059 90	disc	1	2
8	09 23 10 012 90	nut	1	2